		
EN	Old appliances marked with the pictured symbol must be disposed of with the trash. You must return them to a waste collection center (inquire at your local community) or the retailer where they were purchased.	CE is the abbreviation for Conformité européenne - And means Conforms to the European guidelines. With the CE mark, the manufacturer confirms that this product complies with the current European guidelines.
IT	I vecchi apparecchi contrassegnati con il simbolo rappresentato non devono essere smaltiti con la spazzatura. È necessario restituirli a un centro di raccolta rifiuti (informarsi presso la propria comunità locale) o al rivenditore presso cui sono stati acquistati.	CE è l'abbreviazione di Conformité européenne - E significa Conforme alle linee guida europee. Con il marchio CE, il produttore conferma che questo prodotto è conforme all'attuale europeo linee guida.
FR	Ne pas jeter d'appareils portant le symbole ci-contre avec les déchets domestiques. Vous devez déposer le produit à un point de collecte approprié ou chez le revendeur (Pour plus d'informations, veuillez contacter l'autorité locale responsable de la gestion des déchets et du recyclage).	CE est l'abréviation de Conformité européenne - qui signifie «Conforme aux directives de l'UE». Avec le marquage CE, le fabricant confirme que ce produit est conforme aux directives européennes applicables.
DE	Altgeräte, die mit dem abgebildeten Symbol gekennzeichnet sind, dürfen nicht in den Hausmüll entsorgt werden. Sie müssen sie bei einer Sammelstelle für Altgeräte (erkundigen Sie sich bitte bei Ihrer Gemeinde) oder dem Händler, bei dem es gekauft wurde abgeben werden.	CE ist die Abkürzung für Conformité européenne - und bedeutet „Entspricht den EU-Richtlinien“. Mit der CE-Kennzeichnung bestätigt der Hersteller, dass dieses Produkt die geltenden europäischen Richtlinien erfüllt.“
ES	Los electrodomésticos viejos marcados con el símbolo de la imagen no deben desecharse con la basura. Debe devolverlos a un centro de recolección de desechos (consulte a su comunidad local) o al minorista donde los compraron.	CE es la abreviatura de Conformité européenne - And means Cumple con las directrices europeas. Con la marca CE, el fabricante confirma que este producto cumple con las directrices europeas vigentes.
PO	Appliances antigas marcadas com o símbolo da foto não devem ser descartadas com o lixo. Você deve devolvê-las a um centro de coleta de resíduos (Informe-se em sua comunidade local) ou ao revendedor onde eles foram comprados.	CE é a abreviatura de Conformité européenne - And means Em conformidade com as orientações europeias. Com a marca CE, o fabricante confirma que este produto está em conformidade com o atual diretrizes.

FAVOUR







USER GUIDE

AIRBAND H1411

Please read this manual carefully before using the product as it contains important operating information.

-  **100 LUMENS**
-  **20H**
-  **LIGHTWEIGHT & COMPACT**
-  **FREE PROJECTION ANGLE**
-  **WHITE LED - HIGH**
-  **WHITE LED - LOW**
-  **RED LED - 2HZ FLASHING**
-  **WATER RESISTANT**

ANSI FL 1

ANSI FL 1						
WHITE HIGH	100 Lumens	750cd	55m	6h		
WHITE LOW	25 Lumens	180cd	27m	20h		
RED ON	1 Lumen	6cd	5m	60h	✓	✓
RED 2Hz FLASHING*	NA	NA	NA	115h		

* Flashing mode specifications cannot be measured by ANSI FL1 Standard.
* Flashing mode runtime is based on measurement of battery capacity change only.

BATTERY REPLACEMENT DIAGRAM

- Twist off the battery cover.
- Remove old battery and replace one 1.5V AA size Alkaline Battery according to the polarity mark.
- Replace the battery cover back on.

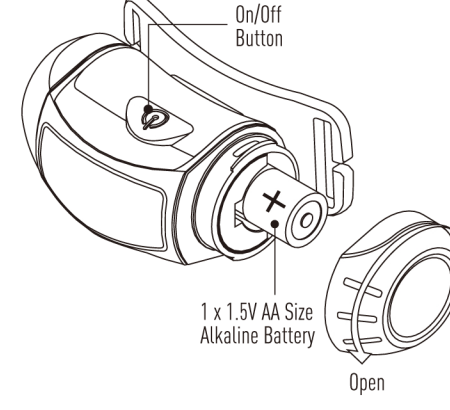

ENGLISH SPECIFICATIONS

- FEATURES**
- 3W Gen 2 LG White LED – Up to 100 Lumens
 - Additional 5mm Red LED for Night Vision
 - 4 Lighting Modes satisfy Different Lighting Needs
 - White LED – HIGH & LOW
 - Red LED – ON & FLASHING
 - Compact Design at merely 65g Weight Offers Optional Comfort on Head
 - Big Switch for Easy Operation even when Wearing Gloves
 - Operates with 1AA Battery
 - Free Projection Angle
 - Water Resistant
- OPERATION**
- WHITE HIGH > WHITE LOW > RED ON > RED 2HZ FLASHING > OFF (Press OFF if stays at any mode over 10 seconds)
- BATTERY TYPE**
- 1 x 1.5V AA Alkaline Battery (Included)
- BULB TYPE**
- 1 x 3W Gen 2 LG White LED
1 x 05mm Red LED
- SIZE**
- 28mm x 59mm x 37mm
- WEIGHT**
- 65g (With Battery)
- !WARNING**
- Do NOT look directly into the LED light for more than a few seconds.
 - Do NOT allow children to use LED light unless under the supervision of an adult.
 - Remove the batteries if not using the LED light for long period or before storage.

ITALINO SPECIFICHE

- CARATTERISTICHE**
- 1 LED 3W Gen 2 LG bianco – fino a 100 lumens
 - Ulteriore LED rosso 5mm per visione notturna
 - 4 modalità d'illuminazione soddisfano diverse richieste d'illuminazione
 - LED bianco - alto e basso
 - LED rosso - on e lampeggiante
 - Design compatto e peso leggero di circa 65g confortevole quando montata sulla testa
 - Pulsante grande per facilitarne l'accensione e lo spegnimento anche indossando guanti
 - Funziona con 1 batteria AA
 - Angolo di proiezione libero
 - Resistente all'acqua
- FUNZIONAMENTO**
- BIANCO ALTO > BIANCOMEDIO > ROSSO ON > ROSSO 2HZ LAMPEGGIANTE > OFF
- TIPO DI BATTERIA**
- 1 x 1,5 AA batteria alcalina (Inclusa)
- TIPO DI LED**
- 1 x 3W Gen 2 LG bianco
1 x 5mm LED rosso
- DIMENSIONI**
- 28mm x 59mm x 37mm

FRANÇAIS SPÉCIFICATIONS

- CARACTÉRISTIQUES**
- 3W Gen 2 LG LED blanc – jusqu'à 100 Lumens
 - LED rouge 5mm supplémentaire pour la vision nocturne
 - 4 modes d'éclairage pour satisfaire les différents besoins d'éclairage
 - LED blanc – HAUT & BAS
 - LED rouge – ON & CLIGNOTANT
 - Design compact avec à peine 65g pour plus de confort sur la tête
 - Gros interrupteur pour une utilisation aisée même avec des gants
 - Fonctionne avec 1 pile AA
 - Angle de projection libre
 - Résistant à l'eau
- FUNCTIONNEMENT**
- BLANC HAUT > BLANC BAS > ROUGE ON > ROUGE 2HZ CLIGNOTANT > OFF
- BATTERIE**
- 1 x pile 1,5V AAA (Fournie)
- TYPE D'AMPOULE**
- 1 x 3W Gen 2 LG LED blanc
1 x 05mm LED rouge
- DIMENSIONS**
- 28mm x 59mm x 37mm
- POIDS**
- 65g (Avec Piles)

DEUTSCHE SPEZIFIKATIONEN

- EIGENSCHAFTEN**
- 3W Gen 2 LG LED weiß – Bis zu 100 Lumen
 - Zusätzliche rote, 5-mm-LED für Nachtsicht
 - 4 Leuchtmodes decken den Bedarf an unterschiedlicher Beleuchtung ab
 - Weiße LED – STARK & GERING
 - Rote LED – EIN & BLINKEN
 - Kompaktes Design bei nur 65g Gewicht, bietet optimalen und bequemen Tragekomfort
 - Großer Schalter für leichte Bedienung, auch mit Handschuhen
 - Wird mit x AA Alkaline Batterie betrieben
 - Freier Projektionswinkel / stufenlos einstellbar
 - Wasserfest
- BEWEIS**
- WEISS STARK > WEISS GERING > ROT EIN > ROT 2-HZ-BLINKEN > AUS
- BATTERIETYP**
- 1 x 1,5 V AA Alkaline Batterien (Im Lieferumfang Enthalten)
- BIERTYP**
- 1 x 3W Gen 2 LG LED weiß
1 x rote LED mit 5mm Ø
- GRÖSSE**
- 28mm x 59mm x 37mm

ESPAÑOL ESPECIFICACIONES

- CARACTERÍSTICAS**
- LED blanco 3W Gen 2 LG – Hasta 100 Lumens
 - LED's 5mm rojos adicionales para visión nocturna
 - 4 Modos de iluminación que satisfacen distintas necesidades
 - LED blanco – HIGH & LOW
 - LED rojo – ON & FLASHING
 - Su diseño compacto y un peso de sólo 65g ofrecen un mayor confort
 - Gran interruptor para fácil manejo con guantes
 - Funciona con 1 pila AA
 - Ángulo libre de proyección
 - Resistente al agua
- FUNCIONAMIENTO**
- BIANCO ALTO > BIANCO LOW > ROJO ON > ROJO 2HZ FLASHING > OFF
- TIPO DE BATERÍA**
- 1 x Pila alcalina 1.5V AA (Incluida)
- TIPO DE BOMBILLA**
- 1 x 3W Gen 2 LG LED Blanco
1 x LED rojo 05mm
- TAMAÑO**
- 28mm x 59mm x 37mm
- PESO**
- 65g (Con Pila)

PORTUGUES ESPECIFICAÇÕES

- CARACTERÍSTICAS**
- LED Branco LG 3W Gen 2 – Até 100 Lumens
 - LED vermelho adicional de 5mm para visão noturna
 - 4 modos de iluminação satisfazem diferentes necessidades de iluminação
 - LED Branco - ALTO E BAIXO
 - LED Vermelho - ON & FLASHING
 - Design compacto com apenas 65g de peso oferece conforto opcional na cabeça
 - Switch Grande para operação fácil mesmo quando usar luvas
 - Opera com bateria 1AA
 - Ângulo de projeção livre
 - À prova de água
- FUNCIONAMENTO**
- BRANCO ALTO > BRANCO BAIXO > VERMELHO LIGADO > PISCAR VERMELHO 2Hz > DESLIGADO
- TIPO DE PILHA**
- 1 x 1,5V AA Pilha Alcalina (Incluída)
- TIPO DE LÂMPADA**
- 1 x 3W Gen 2 LG LED Branco
1 x 05mm LED Vermelho
- DIMENSÕES**
- 28mm x 59mm x 37mm
- PESO**
- 65g (Com Bateria)

NEDERLANDS SPECIFICATIE

- FUNCTIONS**
- 3W Gen 2 LG witte LED - Tot wel 100 lumen
 - Extra 5mm rode LED voor nachtzicht
 - 4 lichtprogramma's voor verschillende lichtbehoeftes
 - Witte LED - HOOG & LAAG
 - Rode LED - AAN & KNIPPEREN
 - Compact design, optimaal draagcomfort door het lage gewicht van 65g
 - Grote schakelaar voor eenvoudige bediening, zelfs met handschoenen aan
 - Werkt op 1 AA batterij
 - Vrije projectiehoek
 - Waterproof
- WERKING**
- WIT HOOG > WIT LAAG > ROOD AAN > ROOD 2HZ KNIPPEREN > UIT
- BATTERIJ**
- 1 x 1,5V AA Alkaline batterij (Inclusief)
- LED**
- 1 x 3W Gen 2 LG witte LED
1 x 05mm rode LED
- AFMETING**
- 28mm x 59mm x 37mm
- GEWICHT**
- 65g (Incl. Batterij)

! WAARSCHUWING

- Kijk NIET langer dan een paar seconden rechtstreeks in het LED-licht.
- Laat kinderen de LED-lamp NIET gebruiken zonder toezicht van een volwassene.
- Verwijder de batterijen als u de LED-lamp langere tijd niet gebruikt of voor u deze opbergt.